



High Quality Audio, Bipolar Input, Dual Operational Amplifier

The **MUSES02** is a dual bipolar input high quality audio operational amplifier, which is optimized for high-end audio and professional audio applications with advanced circuitry and layout, unique material and assembled technology by skilled-craftwork.

It is the best for audio preamplifiers, active filters, and line amplifiers with excellent sound.

■ FEATURES

- | | |
|------------------------|---|
| ● Operating Voltage | $V_{opr} = \pm 3.5V$ to $\pm 16V$ |
| ● Output noise | $4.5nV/\sqrt{Hz}$ at $f=1kHz$ |
| ● Input Offset Voltage | 0.3mV typ. 3mV max. |
| ● Input Bias Current | 100nA typ. 500nA max. at $T_a=25^\circ C$ |
| ● Voltage Gain | 110dB typ. |
| ● Slew Rate | $5V/\mu s$ typ. |
| ● Bipolar Technology | |
| ● Package Outline | DIP8 |

■ PIN CONFIGURATION

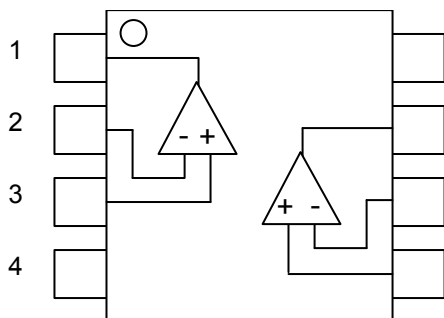

PIN FUNCTION

- | | |
|---|-------------|
| 8 | 1. A OUTPUT |
| 7 | 2. A -INPUT |
| 6 | 3. A +INPUT |
| 5 | 4. V- |
| | 5. B +INPUT |
| | 6. B -INPUT |
| | 7. B OUTPUT |
| | 8. V+ |

■ PACKAGE OUTLINE

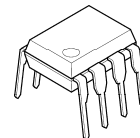

MUSES02



MUSES and this logo are trademarks of New Japan Radio Co., Ltd.

MUSES02

■ ABSOLUTE MAXIMUM RATINGS (Ta=25°C)

PARAMETER	SYMBOL	RATING	UNIT
Supply Voltage	V ⁺ /V	±18	V
Common Mode Input Voltage	V _{ICM}	±15 (Note1)	V
Differential Input Voltage	V _{ID}	±30	V
Power Dissipation	P _D	910	mW
Output Current	I _O	±50	mA
Operating Temperature Range	T _{opr}	-40 to +85	°C
Storage Temperature Range	T _{stg}	-50 to +150	°C

(Note1) For supply Voltages less than ±15 V, the maximum input voltage is equal to the Supply Voltage.

■ RECOMMENDED OPERATING CONDITION (Ta=25°C)

PARAMETER	SYMBOL	TEST CONDITION	MIN.	TYP.	MAX.	UNIT
Supply Voltage	V ⁺ /V	-	±3.5	-	±16	V

■ ELECTRIC CHARACTERISTICS

DC CHARACTERISTICS (V⁺/V=±15V, Ta=25°C unless otherwise specified)

PARAMETER	SYMBOL	TEST CONDITION	MIN.	TYP.	MAX.	UNIT
Operating Current	I _{cc}	No Signal, R _L =∞	-	8.0	12.0	mA
Input Offset Voltage	V _{IO}	R _s ≤10kΩ (Note2)	-	0.3	3.0	mV
Input Bias Current	I _B	(Note2, 3)	-	100	500	nA
Input Offset Current	I _{IO}	(Note2, 3)	-	5	200	nA
Voltage Gain	A _V	R _L ≥2kΩ, V _o =±10V R _s ≤10kΩ	90	110	-	dB
Common Mode Rejection Ratio	CMR	V _{ICM} =±12V (Note4) R _s ≤10kΩ	80	110	-	dB
Supply Voltage Rejection Ratio	SVR	V ⁺ /V=±3.5 to ±16.0V R _s ≤10kΩ (Note2, 5)	80	110	-	dB
Max Output Voltage	V _{OM}	R _L =2kΩ	±12	±13.5	-	V
Input Common Mode Voltage Range	V _{ICM}	CMR≥80dB	±12	±13.5	-	V

(Note2) Measured at V_{ICM}=0V

(Note3) Written by the absolute rate.

(Note4) CMR is calculated by specified change in offset voltage. (V_{ICM}=0V to +12V and V_{ICM}=0V to -12V)

(Note5) SVR is calculated by specified change in offset voltage. (V⁺/V=±3.5V to ±16V)

■ AC CHARACTERISTICS ($V^+V^- = \pm 15V$, $T_a = 25^\circ C$ unless otherwise specified)

PARAMETER	SYMBOL	TEST CONDITION	MIN.	TYP.	MAX.	UNIT
Gain Bandwidth Product	GB	$f = 10kHz$	-	11	-	MHz
Unity Gain Frequency	f_T	$A_V = +100, R_S = 100\Omega,$ $R_L = 2k\Omega, C_L = 10pF$	-	5.8	-	MHz
Phase Margin	ϕ_M	$A_V = +100, R_S = 100\Omega,$ $R_L = 2k\Omega, C_L = 10pF$	-	48	-	deg
Input Noise Voltage1	V_{NI}	$f = 1kHz, A_V = +100,$ $R_S = 100\Omega, R_L = \infty$	-	4.5	-	nV/ \sqrt{Hz}
Input Noise Voltage2	V_{N2}	$f = 1kHz, A_V = +10$ $R_S = 2.2k\Omega,$ RIAA, 30kHz LPF	-	0.8	1.4	μV_{rms}
Total Harmonic Distortion	THD	$f = 1kHz, A_V = +10,$ $R_L = 2k\Omega, V_o = 5V_{rms}$	-	0.001	-	%
Channel Separation	CS	$f = 1kHz, A_V = +100,$ $R_S = 1k\Omega, R_L = 2k\Omega$	-	150	-	dB
Positive Slew Rate	+SR	$A_V = 1, V_{IN} = 2V_{p-p},$ $R_L = 2k\Omega, C_L = 10pF$	-	5	-	V/ μs
Negative Slew Rate	-SR	$A_V = 1, V_{IN} = 2V_{p-p},$ $R_L = 2k\Omega, C_L = 10pF$	-	5	-	V/ μs

■ Application Notes

•Package Power, Power Dissipation and Output Power

IC is heated by own operation and possibly gets damage when the junction power exceeds the acceptable value called Power Dissipation P_D . The dependence of the MUSES02 P_D on ambient temperature is shown in Fig 1. The plots are depended on following two points. The first is P_D on ambient temperature 25°C, which is the maximum power dissipation. The second is 0W, which means that the IC cannot radiate any more. Conforming the maximum junction temperature T_{jmax} to the storage temperature T_{stg} derives this point. Fig.1 is drawn by connecting those points and conforming the P_D lower than 25°C to it on 25°C. The P_D is shown following formula as a function of the ambient temperature between those points.

$$\text{Dissipation Power } P_D = \frac{T_{jmax} - T_a}{\theta_{ja}} \text{ [W]} \quad (T_a=25^\circ\text{C to } T_a=150^\circ\text{C})$$

Where, θ_{ja} is heat thermal resistance which depends on parameters such as package material, frame material and so on. Therefore, P_D is different in each package.

While, the actual measurement of dissipation power on MUSES02 is obtained using following equation.

$$(\text{Actual Dissipation Power}) = (\text{Supply Voltage } V_{DD}) \times (\text{Supply Current } I_{DD}) - (\text{Output Power } P_o)$$

The MUSES02 should be operated in lower than P_D of the actual dissipation power.

To sustain the steady state operation, take account of the Dissipation Power and thermal design.

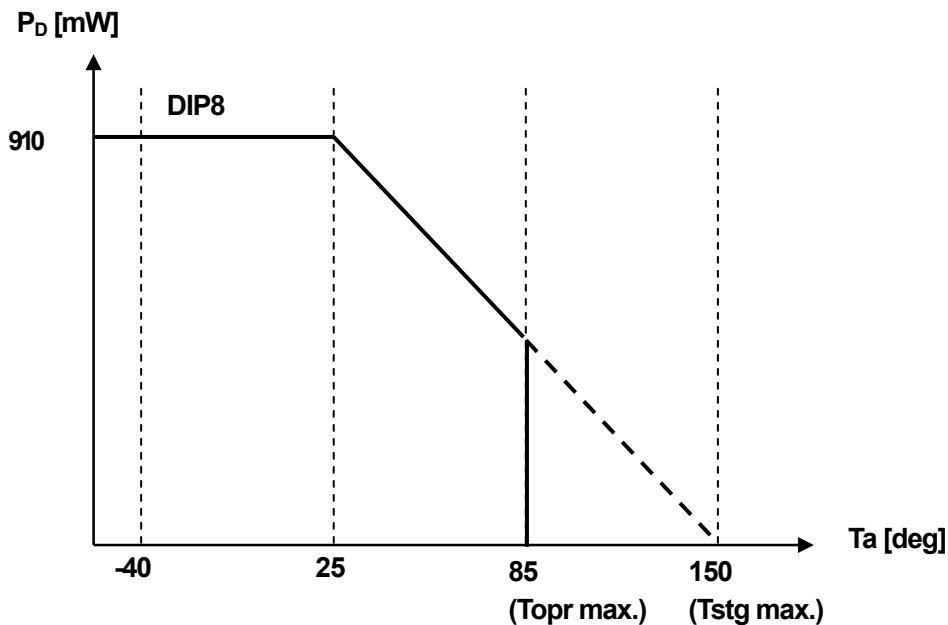
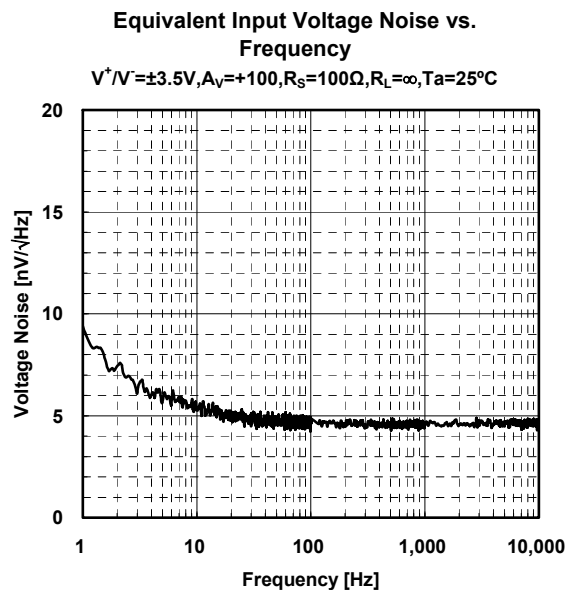
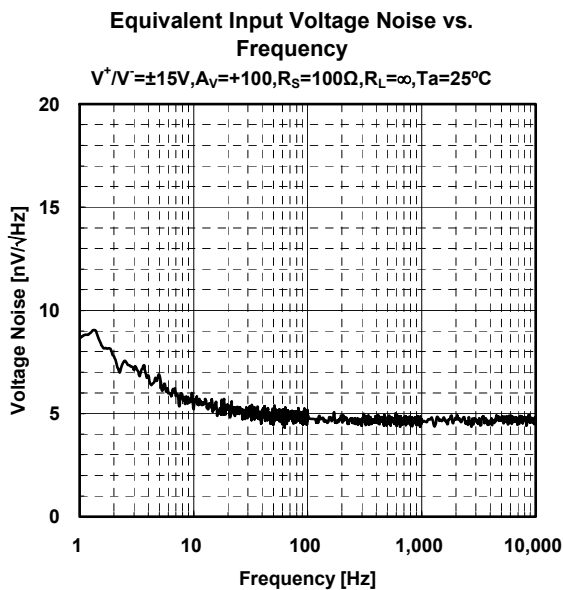
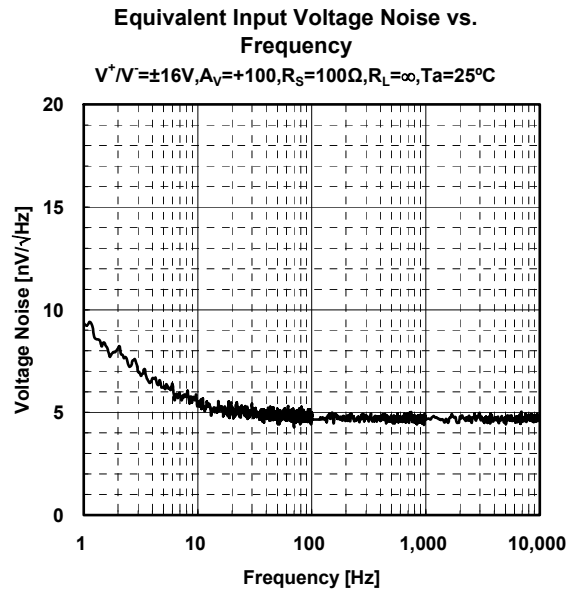
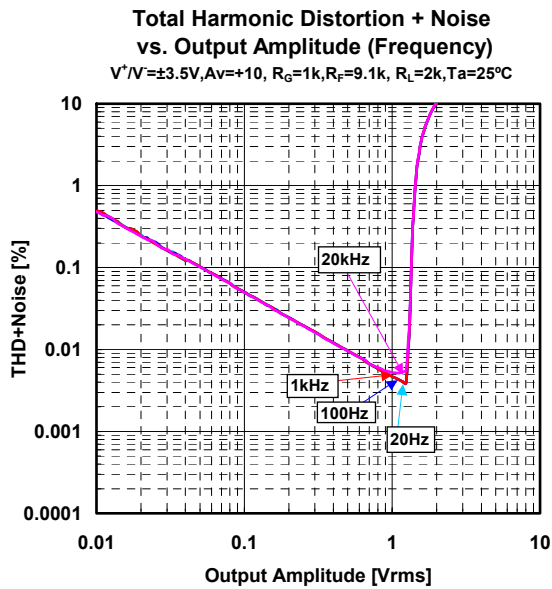
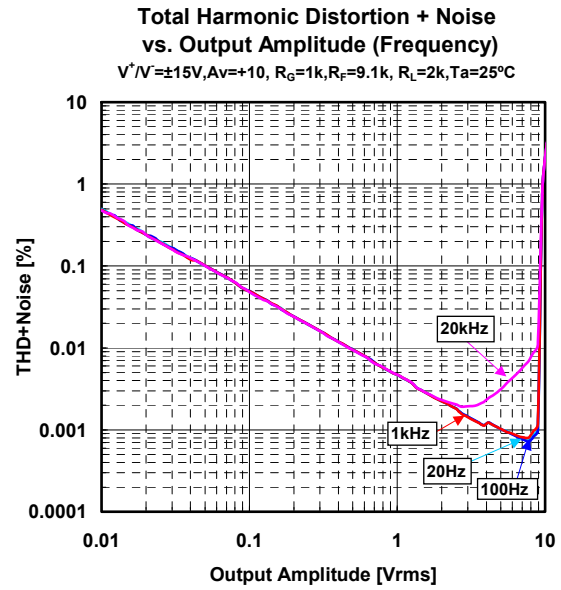
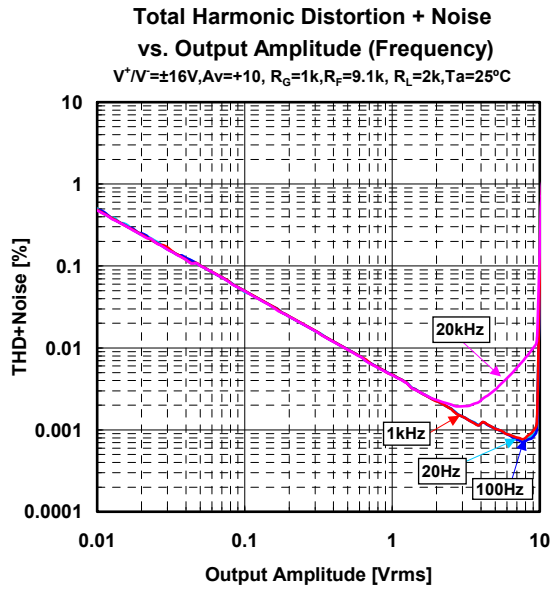
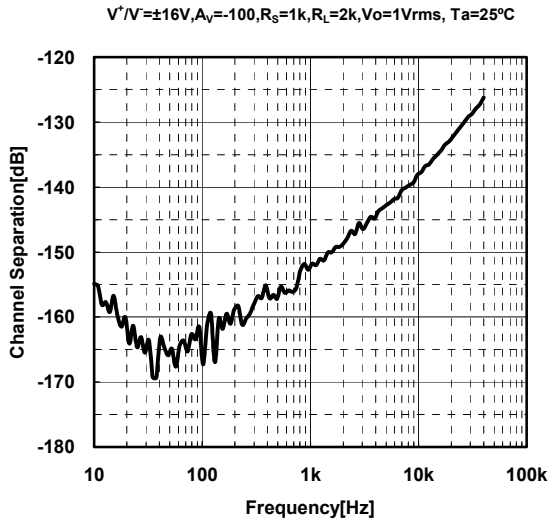

Fig.1 Power Dissipations vs. Ambient Temperature on the MUSES02

■ TYPICAL CHARACTERISTICS



Channel Separation vs. Frequency



Channel Separation vs. Frequency

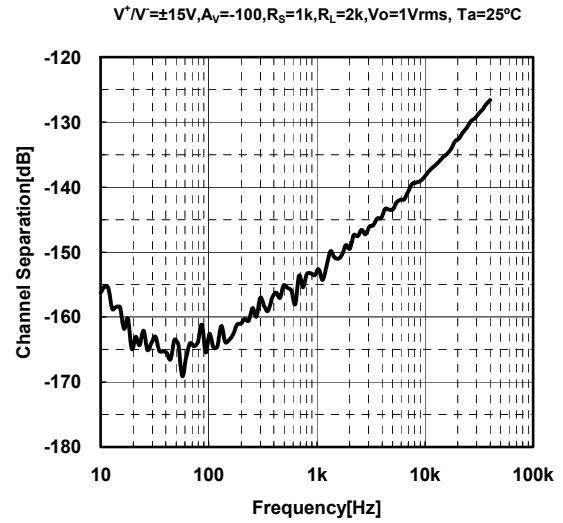

Channel Separation vs. Frequency

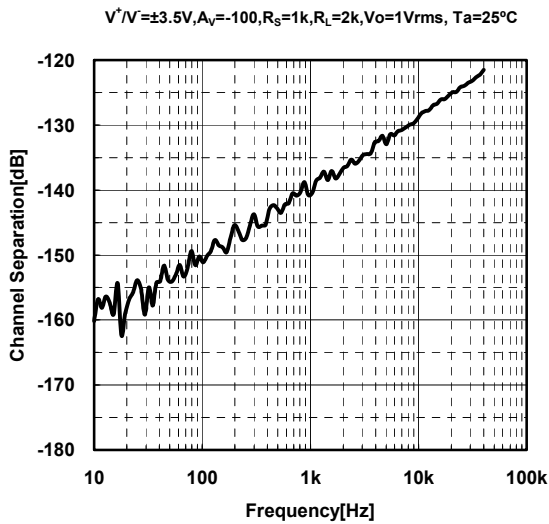

Closed-Loop Gain/Phase vs. Frequency(Temperature)

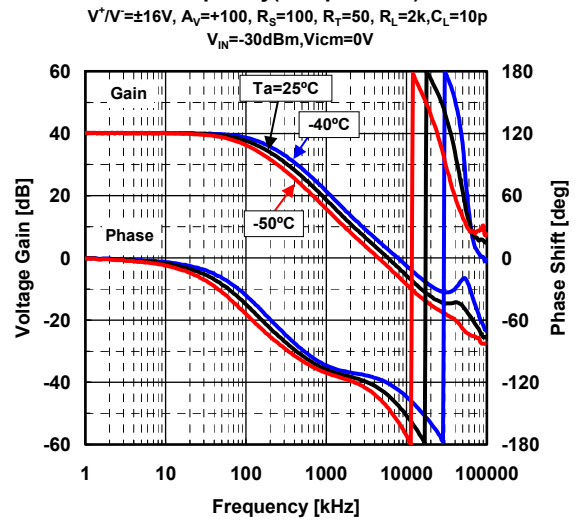

Closed-Loop Gain/Phase vs. Frequency(Temperature)

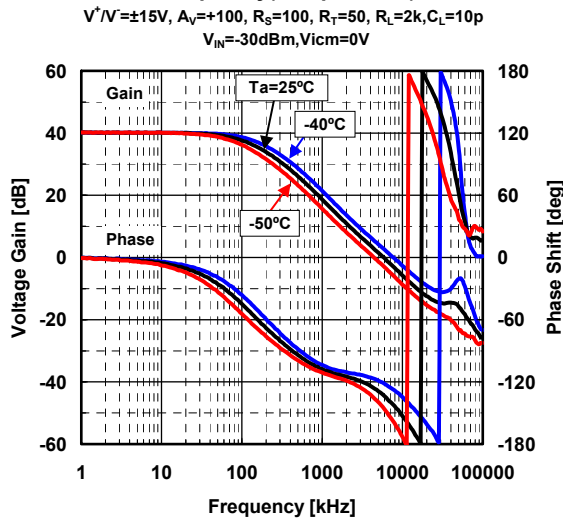

Closed-Loop Gain/Phase vs. Frequency(Temperature)

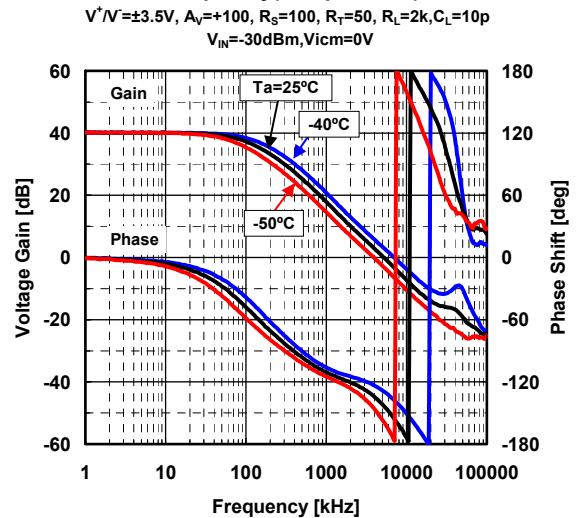

Transient Response (Temperature)

$V^+/V^- = \pm 16V, V_{IN} = 2V_{P-P}, f = 100kHz$
 PulseEdge=10nsec, Gv=0dB, CL=10p, RL=2k

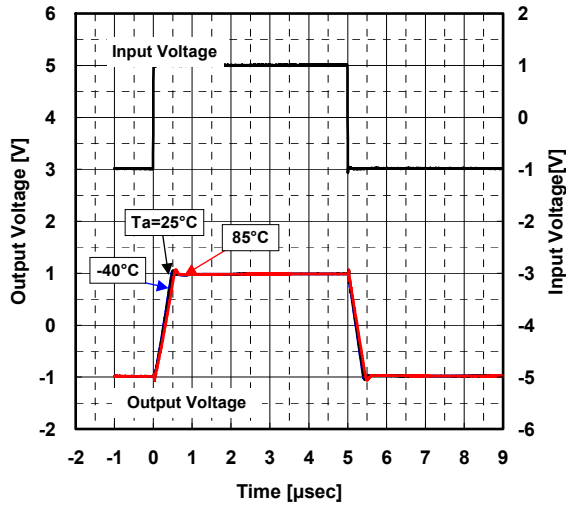

Slew Rate vs. Temperature

$V^+/V^- = \pm 16V, V_{IN} = 2V_{P-P}, f = 100kHz$
 PulseEdge=10nsec, Gv=0dB, CL=10p, RL=2k

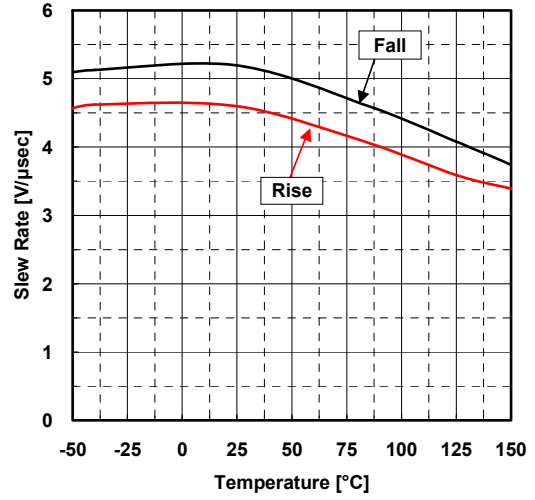

Transient Response (Temperature)

$V^+/V^- = \pm 15V, V_{IN} = 2V_{P-P}, f = 100kHz$
 PulseEdge=10nsec, Gv=0dB, CL=10p, RL=2k

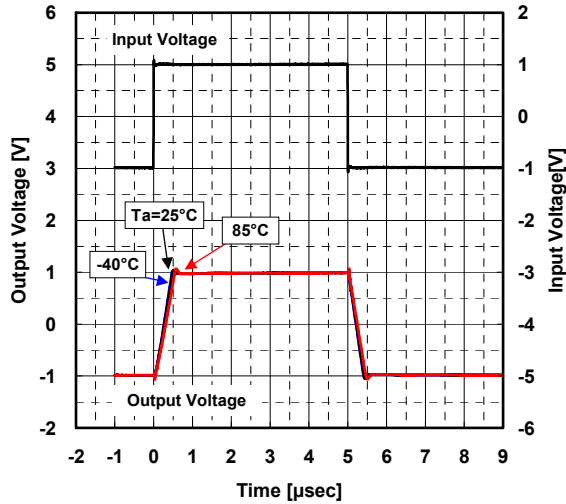

Slew Rate vs. Temperature

$V^+/V^- = \pm 15V, V_{IN} = 2V_{P-P}, f = 100kHz$
 PulseEdge=10nsec, Gv=0dB, CL=10p, RL=2k

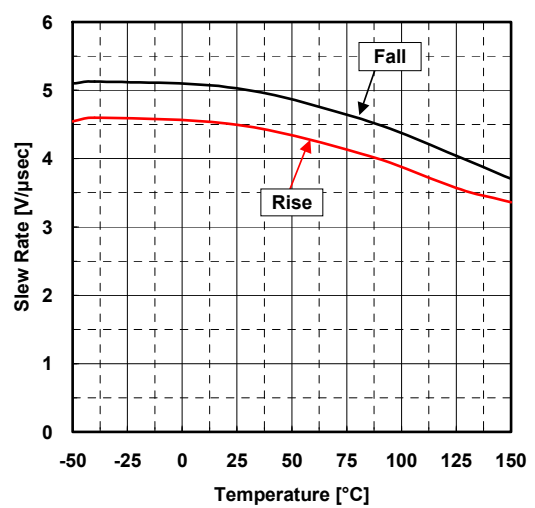

Transient Response (Temperature)

$V^+/V^- = \pm 3.5V, V_{IN} = 2V_{P-P}, f = 100kHz$
 PulseEdge=10nsec, Gv=0dB, CL=10p, RL=2k

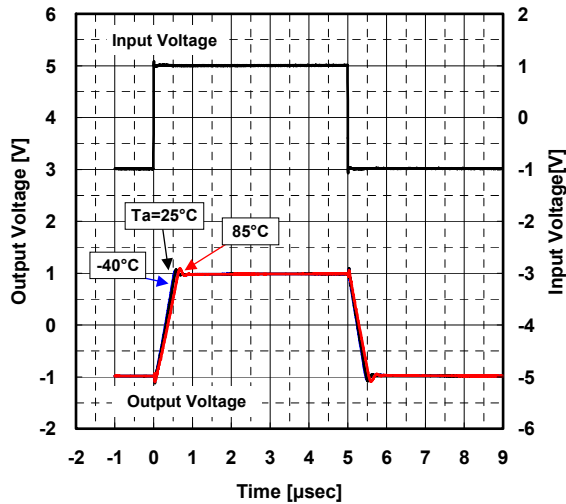

Slew Rate vs. Temperature

$V^+/V^- = \pm 3.5V, V_{IN} = 2V_{P-P}, f = 100kHz$
 PulseEdge=10nsec, Gv=0dB, CL=10p, RL=2k

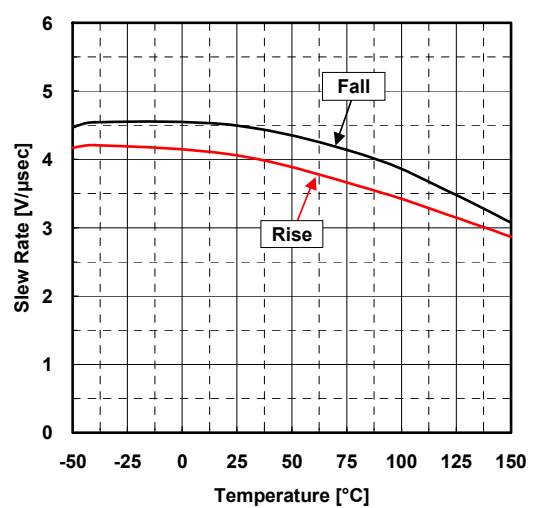

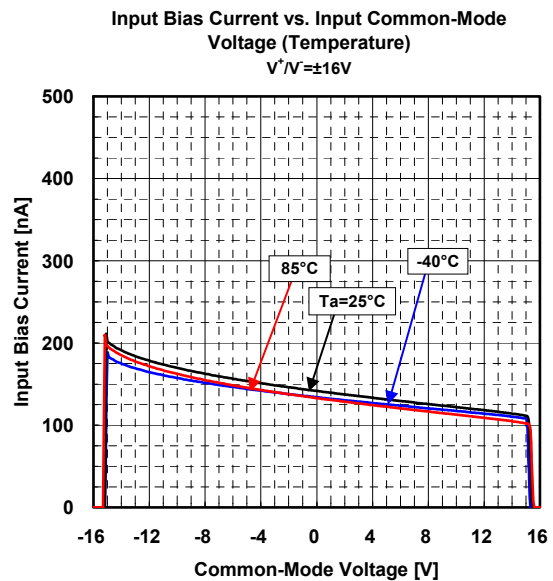
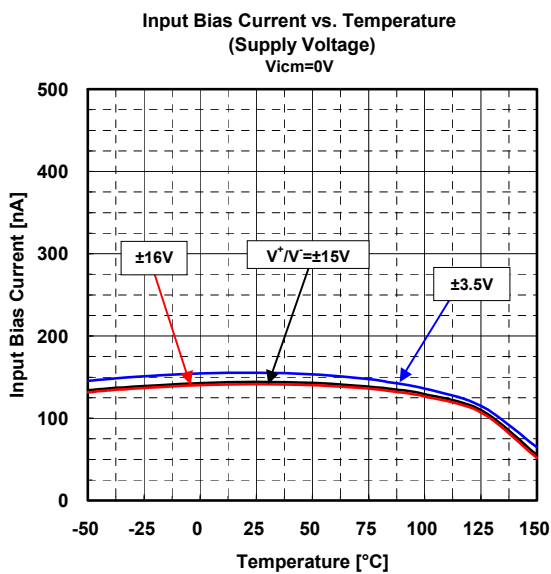
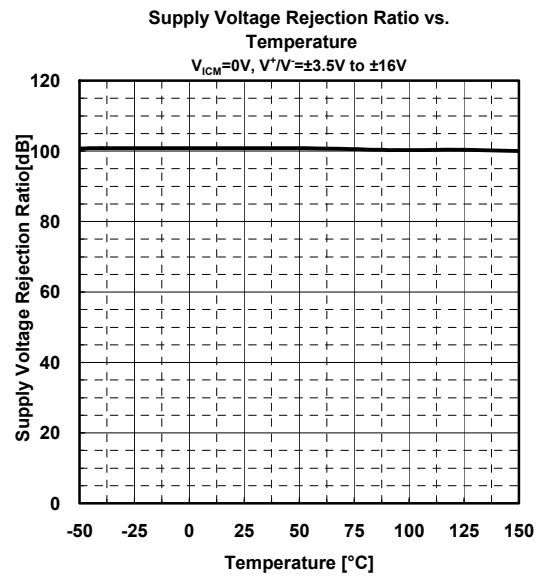
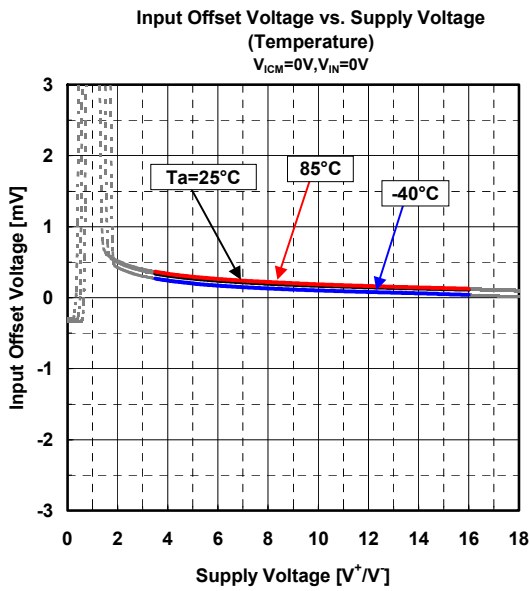
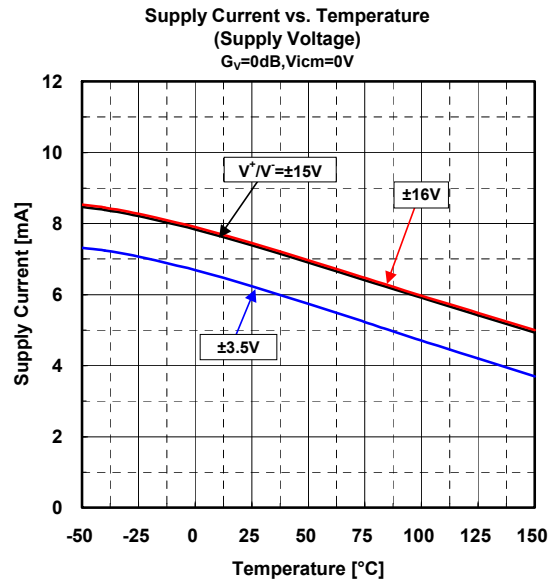
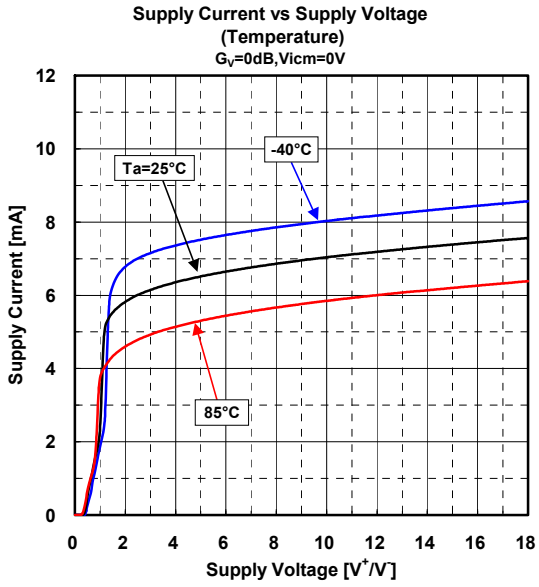

Input Bias Current vs. Input Common-Mode Voltage (Temperature)
 $V^+/V^-\pm 15V$

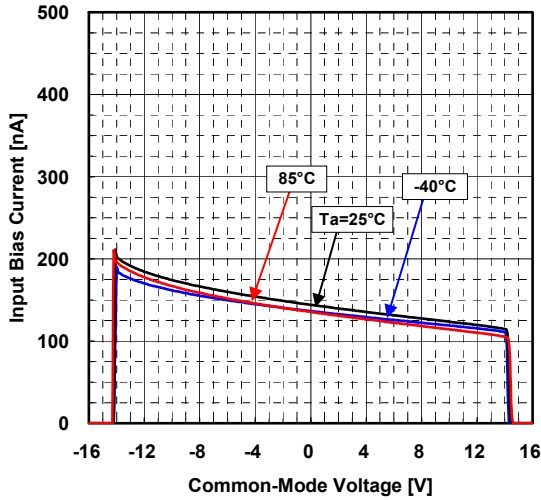

Input Bias Current vs. Input Common-Mode Voltage (Temperature)
 $V^+/V^-\pm 3.5V$

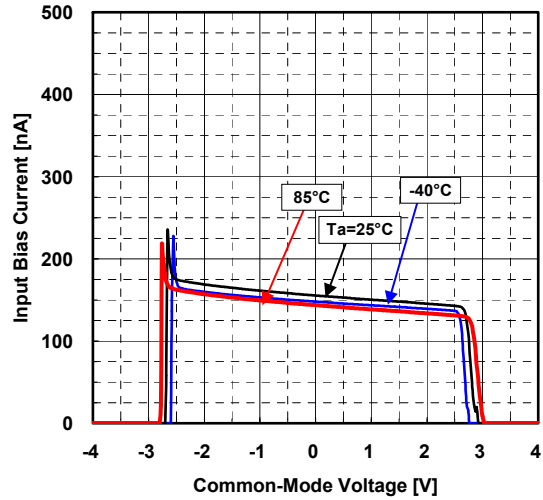

Input Offset Current vs. Temperature (Supply Voltage)
 $V_{icm}=0V$

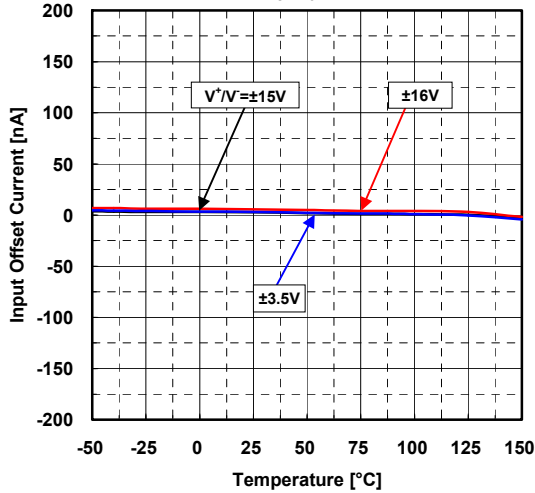

Input Offset Voltage vs. Output Voltage (Temperature)
 $V^+/V^-\pm 15V, R_L=2k\Omega$ to $0V$

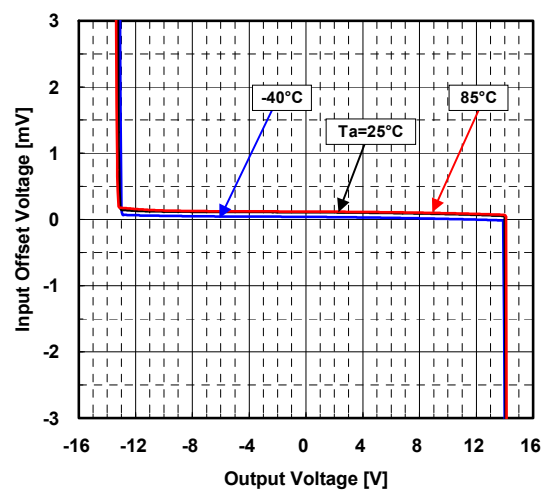

Open-Loop Voltage Gain vs. Temperature
 $R_L=2k\Omega$ to $0V, V^+/V^-\pm 16V, V_o=-11V$ to $+11V$

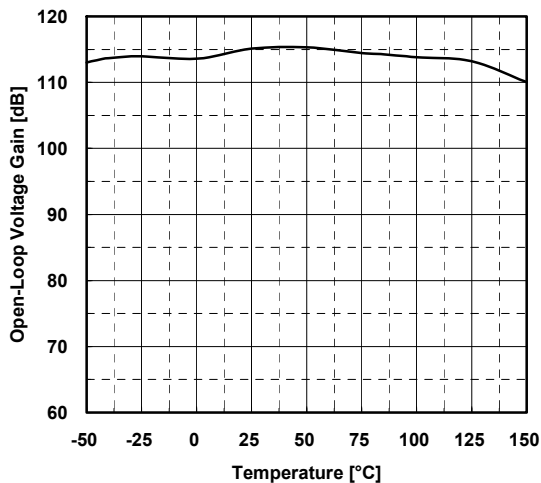

Open-Loop Voltage Gain vs. Temperature
 $R_L=2k\Omega$ to $0V, V^+/V^-\pm 15V, V_o=-10V$ to $+10V$

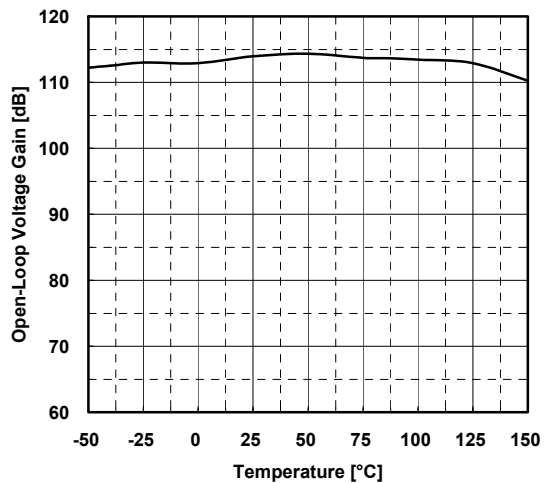

Open-Loop Voltage Gain vs. Temperature
 $R_L=2k\Omega$ to $0V$, $V^+/V^-=\pm 3.5V$, $V_o=-1V$ to $+1V$

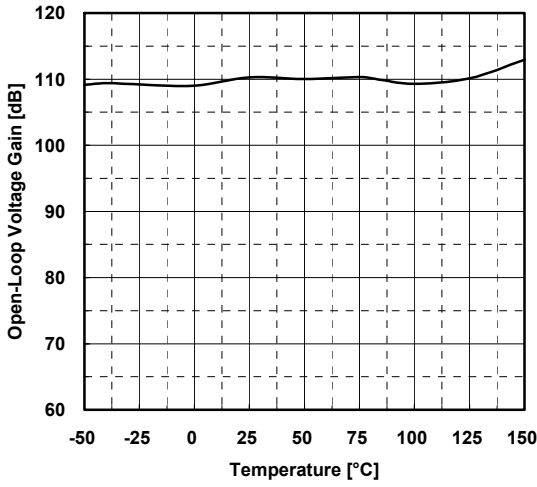

Common-Mode Rejection Ratio vs. Temperature
 (Input Common-Mode Voltage)
 $V^+/V^-=\pm 16V$

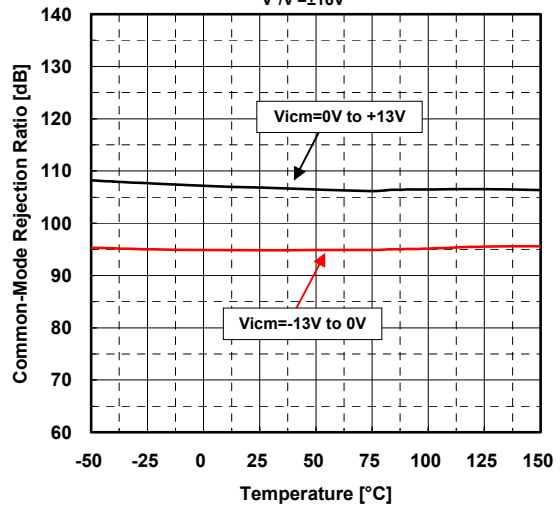

Common-Mode Rejection Ratio vs. Temperature
 (Input Common-Mode Voltage)
 $V^+/V^-=\pm 15V$

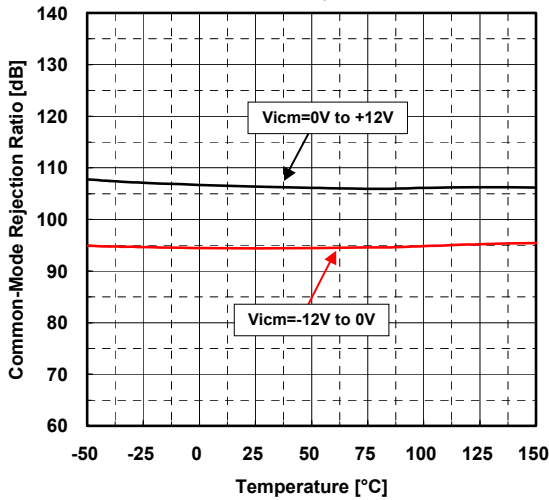

Common-Mode Rejection Ratio vs. Temperature
 (Input Common-Mode Voltage)
 $V^+/V^-=\pm 3.5V$

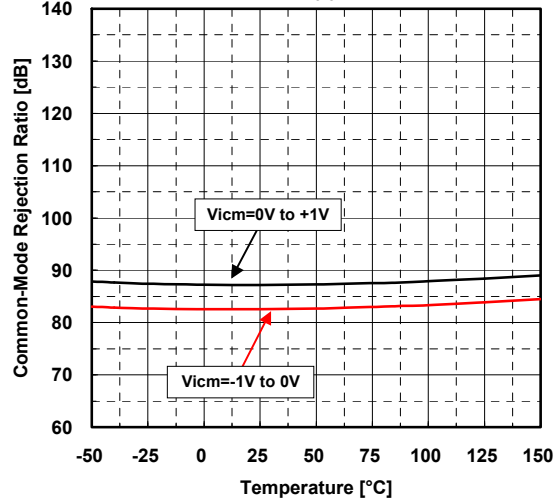

Maximum Output Voltage vs.
 Load Resistance (Temperature)
 $V^+/V^-=\pm 16V$, $G_v=open$, R_L to $0V$

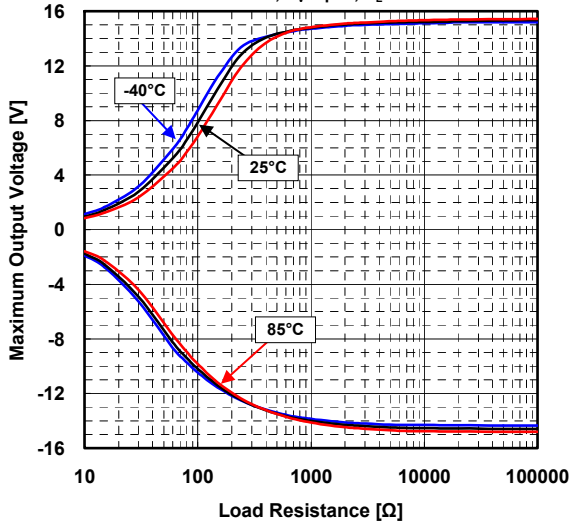

Maximum Output Voltage vs.
 Load Resistance (Temperature)
 $V^+/V^-=\pm 15V$, $G_v=open$, R_L to $0V$

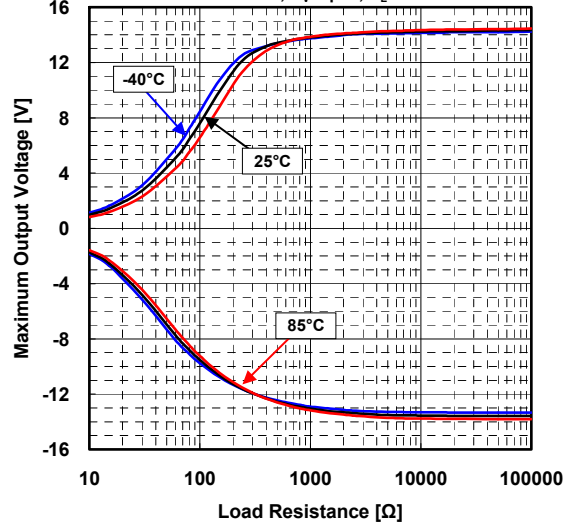

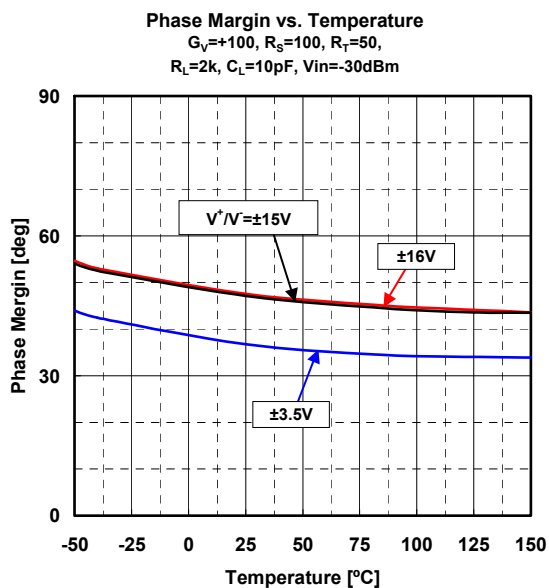
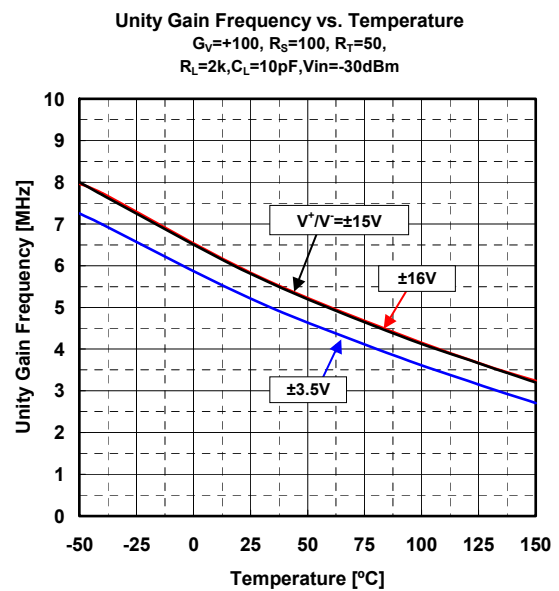
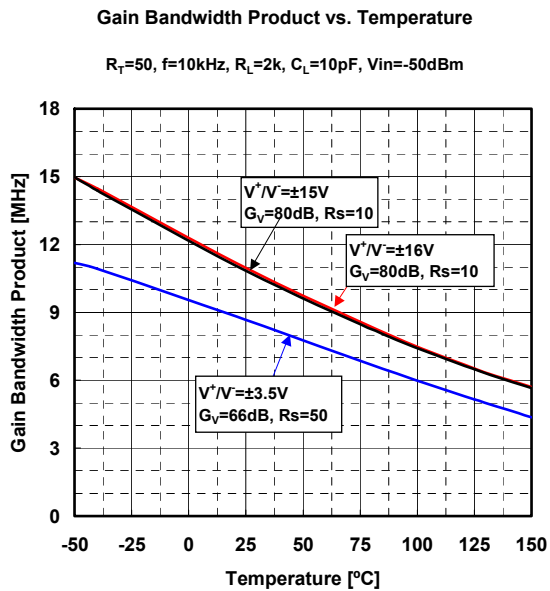
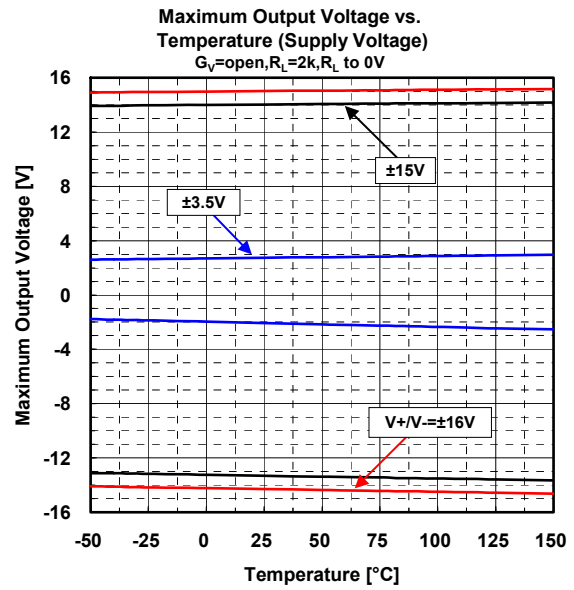
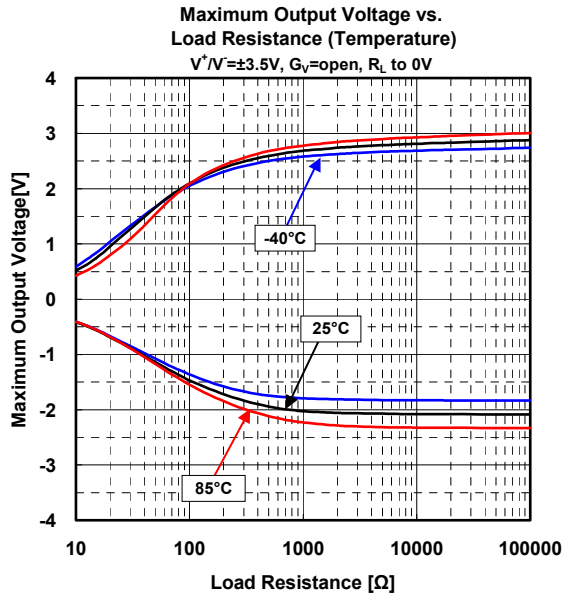

MEMO

[CAUTION]
The specifications on this databook are only given for information, without any guarantee as regards either mistakes or omissions. The application circuits in this databook are described only to show representative usages of the product and not intended for the guarantee or permission of any right including the industrial rights.

Mouser Electronics

Authorized Distributor

Click to View Pricing, Inventory, Delivery & Lifecycle Information:

[Nisshinbo Micro Devices:](#)

[MUSES02](#)